

Caratteristiche del sistema elastico universale
Characteristics of the rubber suspension units

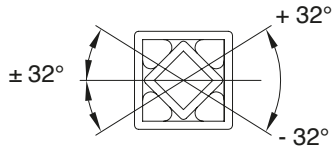

Ampio angolo d'azione
Large operating angle

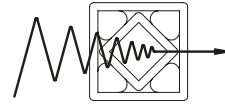

Riduzione di rumore e vibrazioni
Noise and vibration damping

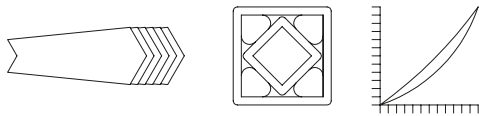

Progressiva elasticità
Progressive spring characteristics

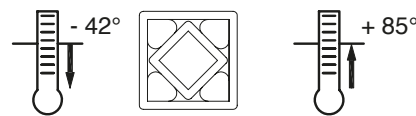

Resistenza alle temperature
Resistant to temperature

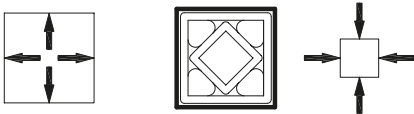

Sicurezza dell'utilizzo
Safe use in any position



Non necessita di manutenzione
Maintenance free

Istruzioni per il corretto montaggio del tendicatena (TEKS) e dei tendicinghia (TERE)

Instructions for a proper mounting of the chain tensioner (TEKS) and of the belt tensioner (TERE)

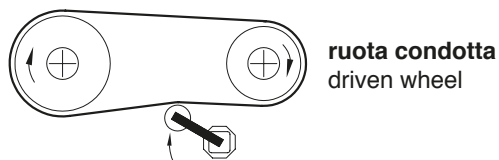

Tenditore sul lato lasco
Tensioner on the loose side

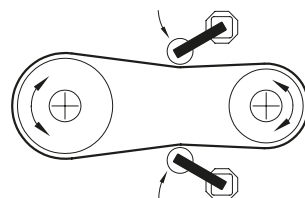

Con motore reversibile montare 2 tendicatena
With reversible engine mount 2 tensioners

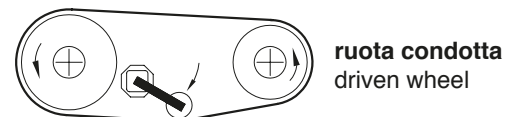

Montaggio con trasmissione a cinghia con profilo a V
Mounting with belt transmission with V profile

Caratteristiche della gomma
Characteristics of the rubber

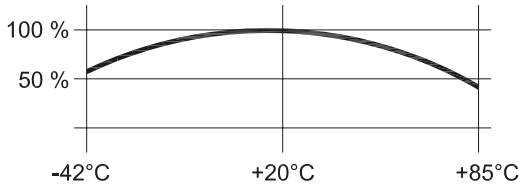

Temperatura ambiente
Room temperature

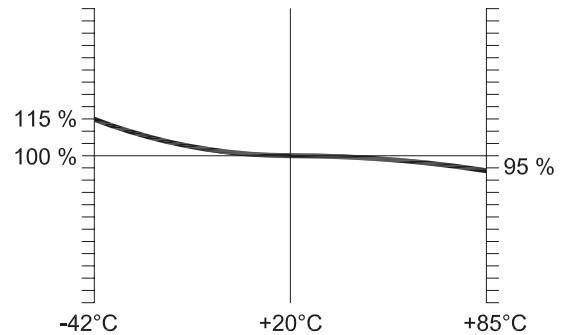

Temperatura ambiente
Room temperature

Durata in condizioni normali di temperatura ~ 10 anni
Temperature influence: service life (under normal conditions) ~ 10 years

Influenza della temperatura: coppia di reazione (N/m)
Temperature influence: torque reaction (N/m)

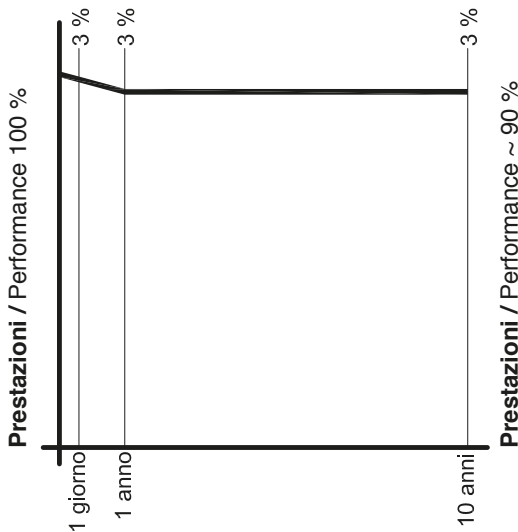

Deformazioni e assestamento della gomma
Could flow and setting

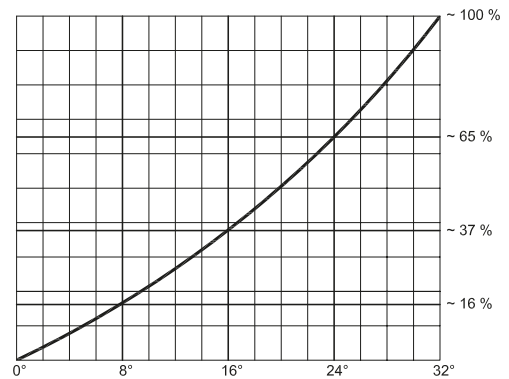

Determinazione della coppia "in percentuale"
Torque determination "in percentage"

Il grafico è applicabile per tutte le dimensioni dei tipi: LTK-S, LTK-A, LTS, LTA

This chart is applicable to all type of: LTK-S, LTK-A, LTS, LTA

Esempio per la determinazione LTS 6-80 con coppia M 215 in Nm a 32° (pag 150)

Example for determinating LTS 6-80 with torque M 215 with Nm a 32° (page 150)

Con angolo di 15° = 35% = ~ 75 Nm

With an angle of 15° = 35% = ~ 75 Nm

Con angolo di 22° = 56% = ~ 120 Nm

With an angle of 22° = 56% = ~ 120 Nm

Con angolo di 28° = 81% = ~ 174 Nm

With an angle of 28° = 81% = ~ 174 Nm



PIGNONI TENDICATENA TIPO "KS" - DIN 8187 SPROCKETS WHEELS TYPE "KS" - DIN 8187

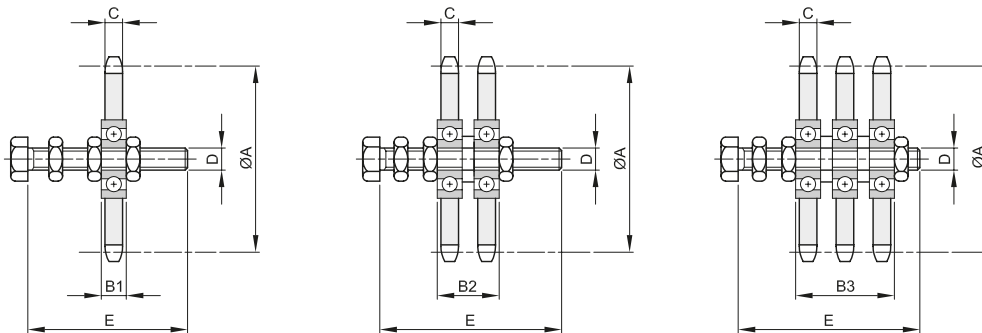

descrizione	codice	ISO	denti	Ø A	B1	B2	B3	C	D	E	semplice Kg.	doppio Kg.	triplo Kg.
KS 3/8" x 7/32"	6022330151	06B-1-2-3	15	45,81	9	19,2	29,4	5,7	M10	60	0,15	0,20	0,25
KS 1/2" x 5/16"	6022340151	08B-1-2	15	61,08	9	22,9		7,2	M10	60	0,20	0,35	
KS 1/2" x 5/16"	6022340152	08B-1-2-3	15	61,08	12	26,0	40,0	7,2	M12	80	0,23	0,45	0,50
KS 5/8" x 3/8"	6022350151	10B-1-2-3	15	76,36	12	28,6	45,2	9,1	M12	80	0,37	0,60	0,95
KS 5/8" x 3/8"	6022350152	10B-1-2-3	15	76,36	15	31,5	48,2	9,1	M20	120	0,70	1,00	1,25
KS 3/4" x 7/16"	6022360151	12B-1-2	15	91,63	12	31,5		11,5	M12	80	0,60	1,05	
KS 3/4" x 7/16"	6022360152	12B-1-2-3	15	91,63	15	34,5	54,0	11,5	M20	120	0,90	1,35	1,50
KS 1" x 17,02	6022380131	16B-1-2-3	13	106,14	15	46,9	78,8	16,2	M20	120	1,30	2,10	2,90
KS 1 1/4" x 3/4"	6022400131	20B-1-2-3	13	132,67	15	51,5	88,0	18,5	M20	140	2,05	3,60	5,20
KS 1 1/2" x 1"	6022420111	24B-1-2-3	11	135,23	15	63,4	111,8	24,1	M20	160	2,40	4,25	6,20



RULLI TENDICINGHIA TIPO "RE" ROLLERSET TYPE "RE"

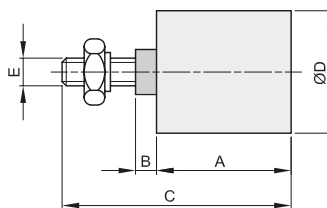

descrizione	codice	A	B	C	Ø D	E	Kg.
RE 2	6023000301	35	3	51	30	M8	0,07
RE 3	6023000401	45	6	67	40	M10	0,17
RE 4	6023000401	45	6	67	40	M10	0,17
RE 5	6023000601	60	7,5	89	60	M12	0,39
RE 6	6023000801	90	9	127	80	M20	1,20
RE 7	6023000802	135	7	167	80	M20	1,70