

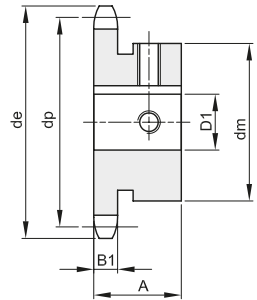

PIGNONI PER CATENE A RULLI "SYSTEM BEA" - DIN 8187 - ISO 606

SPROCKETS FOR ROLLER CHAINS "SYSTEM BEA" - DIN 8187 - ISO 606

1/2" x 5/16"
12,7 x 7,75 mm
Rullo 8,51 mm
08B-1

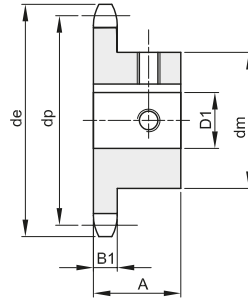
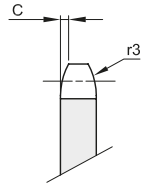

TIPO *

Materiale: Acciaio C45

Z	de	dp	codice	dm	D1	A	Kg.
10	45,9	41,10	SB101340010012	26	12	25	0,12
10	45,9	41,10	SB101340010014	26	14	25	0,11
10	45,9	41,10	SB101340010015	31*	15	25	0,12
10	45,9	41,10	SB101340010016	31*	16	25	0,12
11	49,9	45,07	SB101340011012	29	12	25	0,15
11	49,9	45,07	SB101340011014	29	14	25	0,14
11	49,9	45,07	SB101340011015	31*	15	25	0,14
11	49,9	45,07	SB101340011016	31*	16	25	0,14
11	49,9	45,07	SB101340011018	37*	18	25	0,16
11	49,9	45,07	SB101340011019	37*	19	25	0,16
12	53,9	49,07	SB101340012012	33	12	28	0,21
12	53,9	49,07	SB101340012014	33	14	28	0,20
12	53,9	49,07	SB101340012015	33	15	28	0,19
12	53,9	49,07	SB101340012016	33	16	28	0,19
12	53,9	49,07	SB101340012018	33	18	28	0,18
12	53,9	49,07	SB101340012019	33	19	28	0,17
12	53,9	49,07	SB101340012020	33	20	28	0,17
12	53,9	49,07	SB101340012022	40*	22	28	0,20
12	53,9	49,07	SB101340012024	41*	24	28	0,19
12	53,9	49,07	SB101340012025	42*	25	28	0,19
13	57,9	56,06	SB101340013012	33	12	28	0,27
13	57,9	56,06	SB101340013014	33	14	28	0,26
13	57,9	56,06	SB101340013015	37	15	28	0,26
13	57,9	56,06	SB101340013016	37	16	28	0,25
13	57,9	56,06	SB101340013018	37	18	28	0,24
13	57,9	56,06	SB101340013019	37	19	28	0,23
13	57,9	56,06	SB101340013020	37	20	28	0,22
13	57,9	56,06	SB101340013022	37	22	28	0,21
13	57,9	56,06	SB101340013024	42*	24	28	0,22
13	57,9	56,06	SB101340013025	42*	25	28	0,21
13	57,9	56,06	SB101340013028	45*	28	28	0,21
14	61,9	57,07	SB101340014012	37	12	28	0,32
14	61,9	57,07	SB101340014014	37	14	28	0,31
14	61,9	57,07	SB101340014015	41	15	28	0,31
14	61,9	57,07	SB101340014016	41	16	28	0,30
14	61,9	57,07	SB101340014018	41	18	28	0,29
14	61,9	57,07	SB101340014019	41	19	28	0,28
14	61,9	57,07	SB101340014020	41	20	28	0,28
14	61,9	57,07	SB101340014022	41	22	28	0,27
14	61,9	57,07	SB101340014024	41	24	28	0,25
14	61,9	57,07	SB101340014025	41	25	28	0,24
14	61,9	57,07	SB101340014028	48*	28	28	0,27
15	65,9	61,09	SB101340015012	37	12	28	0,37
15	65,9	61,09	SB101340015014	37	14	28	0,36
15	65,9	61,09	SB101340015015	45	15	28	0,37

Z	de	dp	codice	dm	D1	A	Kg.
15	65,9	61,09	SB101340015016	45	16	28	0,37
15	65,9	61,09	SB101340015018	45	18	28	0,36
15	65,9	61,09	SB101340015019	45	19	28	0,35
15	65,9	61,09	SB101340015020	45	20	28	0,34
15	65,9	61,09	SB101340015022	45	22	28	0,32
15	65,9	61,09	SB101340015024	45	24	28	0,31
15	65,9	61,09	SB101340015025	45	25	28	0,30
15	65,9	61,09	SB101340015028	45	28	28	0,27
15	65,9	61,09	SB101340015030	52*	30	28	0,32
15	65,9	61,09	SB101340015032	52*	32	28	0,30
16	69,9	65,10	SB101340016015	50	15	28	0,47
16	69,9	65,10	SB101340016016	50	16	28	0,46
16	69,9	65,10	SB101340016018	50	18	28	0,44
16	69,9	65,10	SB101340016019	50	19	28	0,43
16	69,9	65,10	SB101340016020	50	20	28	0,43
16	69,9	65,10	SB101340016022	50	22	28	0,40
16	69,9	65,10	SB101340016024	50	24	28	0,39
16	69,9	65,10	SB101340016025	50	25	28	0,38
16	69,9	65,10	SB101340016028	50	28	28	0,35
16	69,9	65,10	SB101340016030	50	30	28	0,34
16	69,9	65,10	SB101340016032	57*	32	28	0,40
17	74,0	69,11	SB101340017015	52	15	28	0,51
17	74,0	69,11	SB101340017016	52	16	28	0,51
17	74,0	69,11	SB101340017018	52	18	28	0,49
17	74,0	69,11	SB101340017019	52	19	28	0,48
17	74,0	69,11	SB101340017020	52	20	28	0,47
17	74,0	69,11	SB101340017022	52	22	28	0,45
17	74,0	69,11	SB101340017024	52	24	28	0,44
17	74,0	69,11	SB101340017025	52	25	28	0,43
17	74,0	69,11	SB101340017028	52	28	28	0,40
17	74,0	69,11	SB101340017030	52	30	28	0,39
17	74,0	69,11	SB101340017032	52	32	28	0,38
18	78,0	73,14	SB101340018016	52	16	28	0,53
18	78,0	73,14	SB101340018018	52	18	28	0,51
18	78,0	73,14	SB101340018019	52	19	28	0,50
18	78,0	73,14	SB101340018020	56	20	28	0,55
18	78,0	73,14	SB101340018022	56	22	28	0,53
18	78,0	73,14	SB101340018024	56	24	28	0,52
18	78,0	73,14	SB101340018025	56	25	28	0,51
18	78,0	73,14	SB101340018028	56	28	28	0,48
18	78,0	73,14	SB101340018030	56	30	28	0,46
18	78,0	73,14	SB101340018032	56	32	28	0,43
18	78,0	73,14	SB101340018035	56	35	28	0,41
18	78,0	73,14	SB101340018038	56	38	28	0,39
19	82,0	77,16	SB101340019016	52	16	28	0,55



PIGNONI PER CATENE A RULLI "SYSTEM BEA" - DIN 8187 - ISO 606 SPROCKETS FOR ROLLER CHAINS "SYSTEM BEA" - DIN 8187 - ISO 606

1/2" x 5/16"
12,7 x 7,75 mm
Rullo 8,51 mm
08B-1

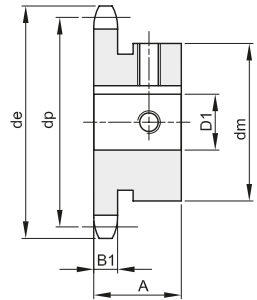
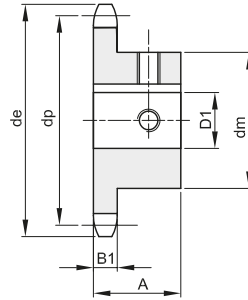
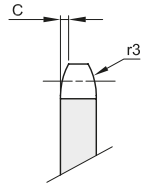

TIPO *

Materiale: Acciaio C45

Z	de	dp	codice	dm	D1	A	Kg.
19	82,0	77,16	SB101340019018	52	18	28	0,53
19	82,0	77,16	SB101340019019	52	19	28	0,5
19	82,0	77,16	SB101340019020	60	20	28	0,64
19	82,0	77,16	SB101340019022	60	22	28	0,62
19	82,0	77,16	SB101340019024	60	24	28	0,60
19	82,0	77,16	SB101340019025	60	25	28	0,59
19	82,0	77,16	SB101340019028	60	28	28	0,57
19	82,0	77,16	SB101340019030	60	30	28	0,55
19	82,0	77,16	SB101340019032	60	32	28	0,53
19	82,0	77,16	SB101340019035	60	35	28	0,49
19	82,0	77,16	SB101340019038	60	38	28	0,46
20	86,0	81,19	SB101340020016	55	16	28	0,64
20	86,0	81,19	SB101340020018	55	18	28	0,61
20	86,0	81,19	SB101340020019	55	19	28	0,59
20	86,0	81,19	SB101340020020	64	20	28	0,74
20	86,0	81,19	SB101340020022	64	22	28	0,72
20	86,0	81,19	SB101340020024	64	24	28	0,71
20	86,0	81,19	SB101340020025	64	25	28	0,70
20	86,0	81,19	SB101340020028	64	28	28	0,67
20	86,0	81,19	SB101340020030	64	30	28	0,65
20	86,0	81,19	SB101340020032	64	32	28	0,63
20	86,0	81,19	SB101340020035	64	35	28	0,61
20	86,0	81,19	SB101340020038	64	38	28	0,59
21	90,1	85,22	SB101340021016	55	16	28	0,74
21	90,1	85,22	SB101340021018	55	18	28	0,72
21	90,1	85,22	SB101340021019	55	19	28	0,71
21	90,1	85,22	SB101340021020	60	20	28	0,70
21	90,1	85,22	SB101340021022	60	22	28	0,68
21	90,1	85,22	SB101340021024	68	24	28	0,80
21	90,1	85,22	SB101340021025	68	25	28	0,79
21	90,1	85,22	SB101340021028	68	28	28	0,77
21	90,1	85,22	SB101340021030	68	30	28	0,75
21	90,1	85,22	SB101340021032	68	32	28	0,72
21	90,1	85,22	SB101340021035	68	35	28	0,69
21	90,1	85,22	SB101340021038	68	38	28	0,65
22	94,1	89,24	SB101340022016	55	16	28	0,84
22	94,1	89,24	SB101340022018	55	18	28	0,81
22	94,1	89,24	SB101340022019	55	19	28	0,80
22	94,1	89,24	SB101340022020	65	20	28	0,82
22	94,1	89,24	SB101340022022	65	22	28	0,80
22	94,1	89,24	SB101340022024	70	24	28	0,87
22	94,1	89,24	SB101340022025	70	25	28	0,86
22	94,1	89,24	SB101340022028	70	28	28	0,83
22	94,1	89,24	SB101340022030	70	30	28	0,81
22	94,1	89,24	SB101340022032	70	32	28	0,78

Z	de	dp	codice	dm	D1	A	Kg.
22	94,1	89,24	SB101340022035	70	35	28	0,75
22	94,1	89,24	SB101340022038	70	38	28	0,71
23	98,1	93,27	SB101340023019	65	19	28	0,86
23	98,1	93,27	SB101340023020	65	20	28	0,85
23	98,1	93,27	SB101340023022	70	22	28	0,93
23	98,1	93,27	SB101340023024	70	24	28	0,90
23	98,1	93,27	SB101340023025	70	25	28	0,89
23	98,1	93,27	SB101340023028	70	28	28	0,86
23	98,1	93,27	SB101340023030	70	30	28	0,84
23	98,1	93,27	SB101340023032	70	32	28	0,82
23	98,1	93,27	SB101340023035	70	35	28	0,79
23	98,1	93,27	SB101340023038	70	38	28	0,76
24	102,1	97,29	SB101340024019	65	19	28	0,91
24	102,1	97,29	SB101340024020	65	20	28	0,89
24	102,1	97,29	SB101340024022	70	22	28	0,92
24	102,1	97,29	SB101340024024	70	24	28	0,94
24	102,1	97,29	SB101340024025	70	25	28	0,93
24	102,1	97,29	SB101340024028	70	28	28	0,90
24	102,1	97,29	SB101340024030	70	30	28	0,88
24	102,1	97,29	SB101340024032	70	32	28	0,85
24	102,1	97,29	SB101340024035	70	35	28	0,82
24	102,1	97,29	SB101340024038	70	38	28	0,79
25	106,2	101,33	SB101340025019	65	19	28	0,94
25	106,2	101,33	SB101340025020	65	20	28	0,92
25	106,2	101,33	SB101340025022	70	22	28	0,99
25	106,2	101,33	SB101340025024	70	24	28	0,97
25	106,2	101,33	SB101340025025	70	25	28	0,97
25	106,2	101,33	SB101340025028	70	28	28	0,94
25	106,2	101,33	SB101340025030	70	30	28	0,92
25	106,2	101,33	SB101340025032	70	32	28	0,90
25	106,2	101,33	SB101340025035	70	35	28	0,86
25	106,2	101,33	SB101340025038	70	38	28	0,80
30	126,3	121,50	SB101340030025	75	25	30	1,31
30	126,3	121,50	SB101340030028	75	28	30	1,28
30	126,3	121,50	SB101340030030	80	30	30	1,37
30	126,3	121,50	SB101340030032	80	32	30	1,34
30	126,3	121,50	SB101340030035	80	35	30	1,31
30	126,3	121,50	SB101340030038	80	38	30	1,28



PIGNONI PER CATENE A RULLI "SYSTEM BEA" - DIN 8187 - ISO 606 SPROCKETS FOR ROLLER CHAINS "SYSTEM BEA" - DIN 8187 - ISO 606

DATI TECNICI - TECHNICAL DATA

Temperati ad induzione sui denti (HRc 50)
Diametro fori in tolleranza H7 - Rugosità RA 1,6
Cave Linguette secondo DIN 6885 / UNI 6604 in asse al dente
N° 2 fori per viti di fissaggio



Teeth: inductioned hardness (HRc 50)
Final bore tolerance H7 - Roughness value RA 1,6
Keyway to DIN 6885 / BS 4235 is located on the center line of tooth
Two grub screw holes

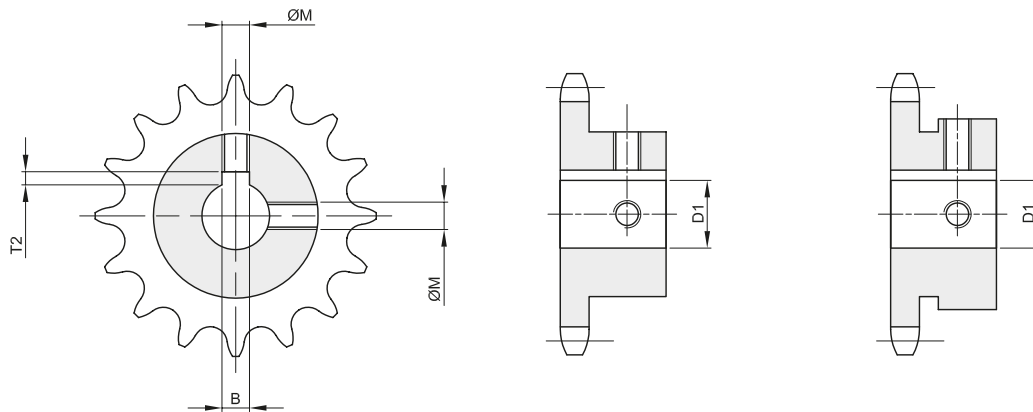

diametro fori D1	larghezza cava B	profondità cava T2	diametro vite Ø M
Ø10 H7 +0,015/-0	3 H9 +0,025/-0	1,4 +0,10/-0	M4
Ø12 H7 +0,018/-0	4 H9 +0,030/-0	1,8 +0,10/-0	M4
Ø14 H7 +0,018/-0	5 H9 +0,030/-0	2,3 +0,10/-0	M4
Ø15 H7 +0,018/-0	5 H9 +0,030/-0	2,3 +0,10/-0	M4
Ø16 H7 +0,018/-0	5 H9 +0,030/-0	2,3 +0,10/-0	M4
Ø18 H7 +0,018/-0	6 H9 +0,030/-0	2,8 +0,10/-0	M5
Ø19 H7 +0,021/-0	6 H9 +0,030/-0	2,8 +0,10/-0	M5
Ø20 H7 +0,021/-0	6 H9 +0,030/-0	2,8 +0,10/-0	M5
Ø22 H7 +0,021/-0	6 H9 +0,030/-0	2,8 +0,10/-0	M5
Ø24 H7 +0,021/-0	8 H9 +0,036/-0	3,3 +0,20/-0	M6
Ø25 H7 +0,021/-0	8 H9 +0,036/-0	3,3 +0,20/-0	M6
Ø28 H7 +0,021/-0	8 H9 +0,036/-0	3,3 +0,20/-0	M6
Ø30 H7 +0,021/-0	8 H9 +0,036/-0	3,3 +0,20/-0	M6
Ø32 H7 +0,025/-0	10 H9 +0,036/-0	3,3 +0,20/-0	M8
Ø35 H7 +0,025/-0	10 H9 +0,036/-0	3,3 +0,20/-0	M8
Ø38 H7 +0,025/-0	10 H9 +0,036/-0	3,3 +0,20/-0	M8
Ø40 H7 +0,025/-0	12 H9 +0,043/-0	3,3 +0,20/-0	M10
Ø42 H7 +0,025/-0	12 H9 +0,043/-0	3,3 +0,20/-0	M10
Ø45 H7 +0,025/-0	14 H9 +0,043/-0	3,8 +0,20/-0	M12
Ø48 H7 +0,025/-0	14 H9 +0,043/-0	3,8 +0,20/-0	M12
Ø50 H7 +0,025/-0	14 H9 +0,043/-0	3,8 +0,20/-0	M12